

Electrode Expert (known as E-Xpert) is an NX integration software developed to help manufacturers to shrink lead times & reduce costs with complex and challenging electrodes. It is a step-by-step solution which can streamline and automate electrode modelling, design, validate, document up to the final steps of tool setup sheets required for EDM process for production.

Following are the benefits:

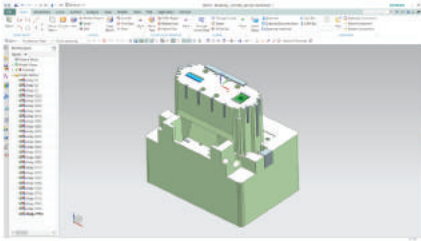

Highly Automated Electrode Design Process

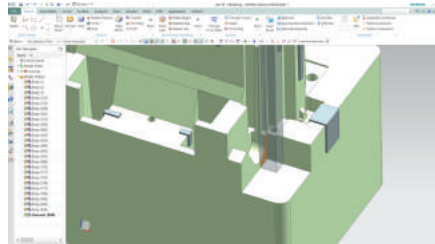

Auto Interference check between Electrode Head and Steel Insert

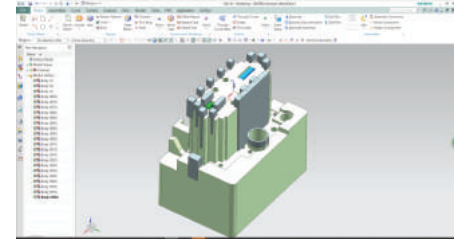

Auto Electrode Head Trimming Process

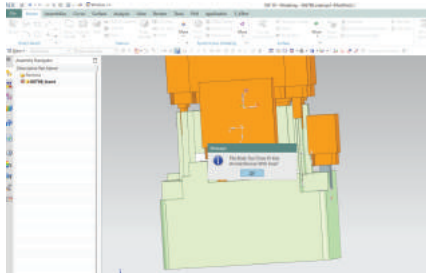

Auto Electrode Body Extension to Avoid Collision between Electrode Holder and Steel Insert



User Friendly User Interface

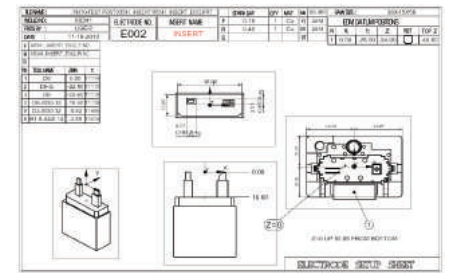

Auto Drafting for EDM Process Drawing (Avoid Human Error on Electrode Positioning)

ITEM	ITEM NAME	UNIT	QTY	WEIGHT	PRICE
1	ABOAT ELECTRODE 0001	PC	1	0.0000	0.00
2	ABOAT ELECTRODE 0002	PC	1	0.0000	0.00
3	ABOAT ELECTRODE 0003	PC	1	0.0000	0.00
4	ABOAT ELECTRODE 0004	PC	1	0.0000	0.00
5	ABOAT ELECTRODE 0005	PC	1	0.0000	0.00
6	ABOAT ELECTRODE 0006	PC	1	0.0000	0.00
7	ABOAT ELECTRODE 0007	PC	1	0.0000	0.00
8	ABOAT ELECTRODE 0008	PC	1	0.0000	0.00
9	ABOAT ELECTRODE 0009	PC	1	0.0000	0.00
10	ABOAT ELECTRODE 0010	PC	1	0.0000	0.00
11	ABOAT ELECTRODE 0011	PC	1	0.0000	0.00
12	ABOAT ELECTRODE 0012	PC	1	0.0000	0.00
13	ABOAT ELECTRODE 0013	PC	1	0.0000	0.00
14	ABOAT ELECTRODE 0014	PC	1	0.0000	0.00
15	ABOAT ELECTRODE 0015	PC	1	0.0000	0.00
16	ABOAT ELECTRODE 0016	PC	1	0.0000	0.00
17	ABOAT ELECTRODE 0017	PC	1	0.0000	0.00
18	ABOAT ELECTRODE 0018	PC	1	0.0000	0.00
19	ABOAT ELECTRODE 0019	PC	1	0.0000	0.00
20	ABOAT ELECTRODE 0020	PC	1	0.0000	0.00
21	ABOAT ELECTRODE 0021	PC	1	0.0000	0.00
22	ABOAT ELECTRODE 0022	PC	1	0.0000	0.00
23	ABOAT ELECTRODE 0023	PC	1	0.0000	0.00
24	ABOAT ELECTRODE 0024	PC	1	0.0000	0.00
25	ABOAT ELECTRODE 0025	PC	1	0.0000	0.00
26	ABOAT ELECTRODE 0026	PC	1	0.0000	0.00
27	ABOAT ELECTRODE 0027	PC	1	0.0000	0.00
28	ABOAT ELECTRODE 0028	PC	1	0.0000	0.00
29	ABOAT ELECTRODE 0029	PC	1	0.0000	0.00
30	ABOAT ELECTRODE 0030	PC	1	0.0000	0.00

Auto Electrode BOM list

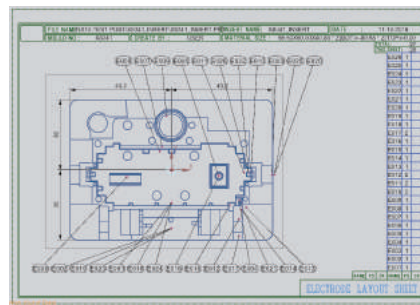

Auto Shop floor Electrode Layout Checklist

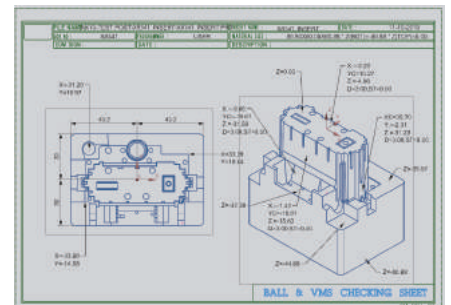

Auto Electrode / Steel Insert QC Check Sheet

ITEM	ITEM NAME	UNIT	QTY	WEIGHT	PRICE
1	CHAMFERING.DIE	PC	1	0.0000	0.00
2	CHAMFERING.DIE	PC	1	0.0000	0.00
3	CHAMFERING.DIE	PC	1	0.0000	0.00
4	CHAMFERING.DIE	PC	1	0.0000	0.00
5	CHAMFERING.DIE	PC	1	0.0000	0.00
6	CHAMFERING.DIE	PC	1	0.0000	0.00
7	CHAMFERING.DIE	PC	1	0.0000	0.00
8	CHAMFERING.DIE	PC	1	0.0000	0.00
9	CHAMFERING.DIE	PC	1	0.0000	0.00
10	CHAMFERING.DIE	PC	1	0.0000	0.00
11	CHAMFERING.DIE	PC	1	0.0000	0.00
12	CHAMFERING.DIE	PC	1	0.0000	0.00
13	CHAMFERING.DIE	PC	1	0.0000	0.00
14	CHAMFERING.DIE	PC	1	0.0000	0.00
15	CHAMFERING.DIE	PC	1	0.0000	0.00
16	CHAMFERING.DIE	PC	1	0.0000	0.00
17	CHAMFERING.DIE	PC	1	0.0000	0.00
18	CHAMFERING.DIE	PC	1	0.0000	0.00
19	CHAMFERING.DIE	PC	1	0.0000	0.00
20	CHAMFERING.DIE	PC	1	0.0000	0.00
21	CHAMFERING.DIE	PC	1	0.0000	0.00
22	CHAMFERING.DIE	PC	1	0.0000	0.00
23	CHAMFERING.DIE	PC	1	0.0000	0.00
24	CHAMFERING.DIE	PC	1	0.0000	0.00
25	CHAMFERING.DIE	PC	1	0.0000	0.00
26	CHAMFERING.DIE	PC	1	0.0000	0.00
27	CHAMFERING.DIE	PC	1	0.0000	0.00
28	CHAMFERING.DIE	PC	1	0.0000	0.00
29	CHAMFERING.DIE	PC	1	0.0000	0.00
30	CHAMFERING.DIE	PC	1	0.0000	0.00

Auto Tool List for Electrode / Steel Insert CAM Machining Program

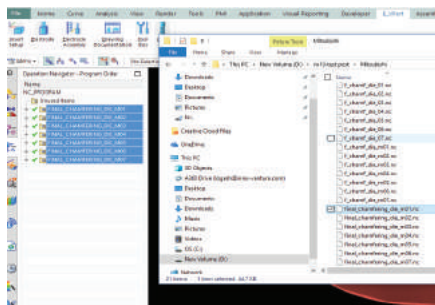

Multiple Groups Machine Post-processing



Scan Here to watch the video